

# DG Flugzeugbau GmbH

Otto-Lilienthal-Weg 2 / Am Flugplatz • D-76646 Bruchsal • Germany

Postbox 1480, D-76604 Bruchsal • Germany

Tel. 07251 3020-100 • Telefax 07251 3020-200 • eMail: dg@dg-flugzeugbau.de

Spare part and material sales: Tel. 07251 3020-270 • lager@dg-flugzeugbau.de

www.dg-flugzeugbau.de

## Flight Manual

for the sailplane

# DG-300

# ELAN

This manual belongs to the sailplane DG-300 Elan and is always to be carried on board

German Data Sheet No.: 359

Factory Serial No:

Year of Construction:

Registration No.:

Manufacturer: ELAN Tovarna Sportnega Orodja,  
YU-64 275 Begunje/Gor., Yugoslavia

Owner:

.....  
.....  
.....

Issued: M a y 1984

The original German Language edition of this manual has been approved as operating instruction according to "§ 12(1) 2. of Luft-Ger Po".

Approval of translation has been done by best knowledge and judgement. In any case the original text in German language is authoritative.

LBA approved: pages 9 - 25 only

**Manual amendments**

No.	page	description	issue date
1	1, 2, 4-6, 8, 10-12, 15, 16, 19, 21, 22, 24, 25, 28, 30, 31, 33	amendments and corrections TN 359/7	May 85
2	4, 17, 21, 33	Installation of an additional tow hook TN 359/8	Oct. 85
3	1, 8, 18	Marking of canopy emergency release and ventilation TN 359/9	June 86
4	cover, 1, 2, 10, 23, 26, 27, 28, 29, 29a	Manual revision TN 359/12	Nov. 86
5	1, 2, 12, 13, 17, 25, 27, 29, 29a	Manual revision TN 359/13	Febr.88
6	2, 27, 27a	Fin waterballast tank - new version ÄM 300/6/E/88	June 88
7	1, 2, 17, 25a, 33	Manual revision TN 359/15	March 91
8	6, 8, 18	Canopy emergency release, seatback new version ÄM 300/10/E/94	June 94
9	2a, 7.1, 7.2, 7.3	Wingtips with Winglets TN 359/17	Okt. 95
10	1, 2, 4, 9 -11, 12, 15, 23, 25a	TN 359/24 Reduction of operating limitations	April 2007

## Flight Manual DG-300

Section	Content	page	issued	replaced	replaced	replaced
<b>1.</b>	<b>General</b>					
1.1	3-Side view	3	Jan. 84			
1.2	Description	4	Jan. 84	Oct. 85	April 07	
	“	5	Jan. 84	Oct. 85		
1.3	Description of the cockpit the controls and details	6	Jan. 84	June 94		
	”	7	Jan. 84			
	„	8	Jan. 84	June 94		
<b>Beginning of JAR 22 required and LBA</b>						
<b>2.</b>	<b>Operating limitations</b>					
2.1	Airworthiness Category	9	Jan. 84	April 07		
2.2	Approved flight regimes	9	Jan. 84	April 07		
2.3	Required minimum equipment placards	10	Jan. 84	Nov. 89	April 07	
2.4	Airspeed limits	11	Jan. 84	May 85	April 07	
2.5	Maximum G-loadings	12	Jan. 84	Febr. 88	April 07	
2.6	Weights	12	Jan. 84	Febr. 88	April 07	
2.7	Center of gravity locations	12	Jan. 84	Febr. 88	April 07	
2.8	Loading chart	13	Jan. 84	Febr. 88		
	“	14	Jan. 84			
	“	15	Jan. 84	May 85	April 07	
	“	16	Jan. 84	May 85		
2.9	Tow Release	17	Jan. 84	March91		
2.10	Weak Links	17	Jan. 84	March91		
2.11	Tire Pressure	17	Jan. 84	March91		
2.12	Crosswinds	17	Jan. 84	March91		
2.13	Length of towing cable	17	Jan. 84	March91		
<b>3.</b>	<b>Emergency procedures</b>					
3.1	Spin recovery	18	Jan. 84	June 94		
3.2	Canopy jettison/Bailout	18	Jan. 84	June 94		
3.3	Recovery from unintentional cloud flying	18	Jan. 84	June 94		
3.4	Landing wheel up	18	Jan. 84	June 94		
3.5	Rain and icing	18a	Jan. 84			
3.6	Leaking water tanks	18a	Jan. 84			

## Flight Manual DG-300

Section	Content	page	issued	replaced	replaced	replaced
<b>4.</b>	<b>Normal operation</b>					
4.1	Daily Inspection	19	Jan. 84	May 85		
4.2	Cockpit Check	20	Jan. 84	May 83		
4.3	Aero tow - winch launch	21	Jan. 84	Oct. 85		
4.4	Free flight	22	Jan. 84	May 85		
4.5	Cloud flying	22	Jan. 84	May 85		
4.6	Aerobatics Category "U"	23	Jan. 84	Nov. 86	April 07	
4.7	Approach and Landing	24	Jan. 84	May 85		
4.8	Flight with water ballast	25	Jan. 84	Febr. 88		
4.9	Flight at high altitude and at low temperature	25a	March91	April 07		
4.10	Flight in rain	25a	March91	April 07		
<b>End of JAR 22 required and LBA approved part</b>						
<b>5.</b>	<b>Rigging and derigging</b>					
5.1	Rigging	26	Jan. 84	Nov. 86		
5.2	Filling the wing water ballast tanks	27	Jan. 84	June 88		
5.3	Filling the fin water ballast tank	27	Jan. 84	June 88		
	“	27a	June 88	June 88		
5.4	Tie Down, Parking	28	Jan. 84	Nov. 86		
5.5	Derigging	28	Jan. 84	Nov. 86		
5.6	Trailerling	28	Jan. 84	Nov. 86		
5.7	Service and care	29	Jan. 84	Febr. 88		
5.8	Towing on the ground	29a	Nov. 86	Febr. 88		
<b>6.</b>	<b>Additional Information</b>					
6.1	Gliding performance	30	Jan. 84	May 85		
	Gliding performance polar	31	Jan. 84	May 85		
	Mc Cready polar	32	Jan. 84			
6.2	Maintenance	33	Jan. 84	March91		
6.3	Repairs and alterations	33	Jan. 84	March91		
6.4	Tow hook	33	Jan. 84	March91		
6.5	Safety harness	33	Jan. 84	March91		
6.6	3000 h Inspection, max.life time	33	Jan. 84	March91		
6.7	Instruments	33	Jan. 84	March91		
6.8	Airspeed calibration	34	Jan. 84			

Flight Manual DG-300 all version

		page	issued
7.	<b>Supplements</b>		
	Supplements	7.1	Oct. 95
	Supplements	7.2	" "
	Wingtips with winglets	7.3	" "

1. General

1.1. 3-Side view

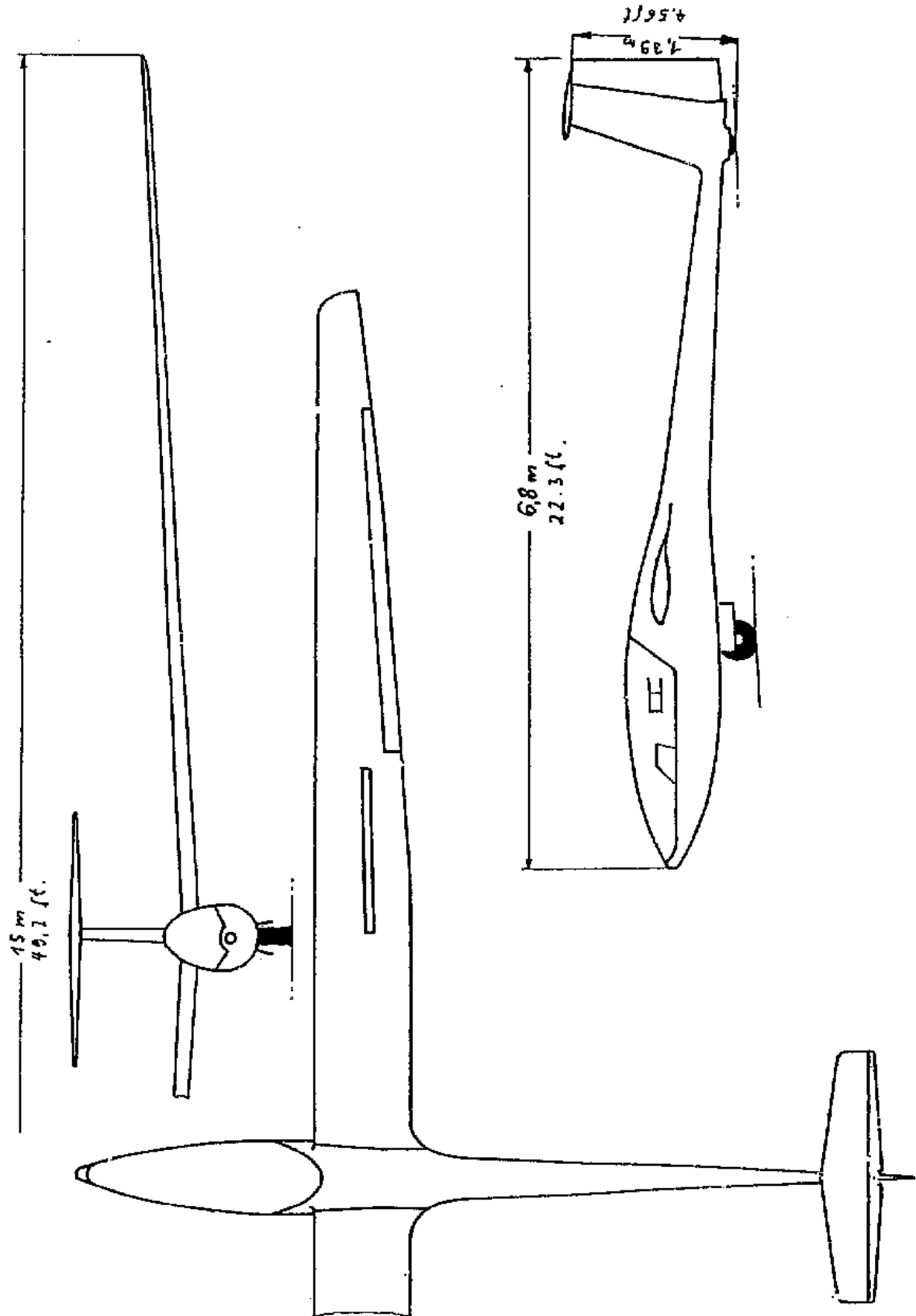

## 1.2 Description

The DG-300 is a single place high performance sailplane, with 15 m wingspan, designed for the FAI Standard Class.

### Technical Data

Wing span	15	m	49.2	ft
Wing surface	10,27	m <sup>2</sup>	110.5	ft <sup>2</sup>
Aspect ratiog	21,91	/	21.91	/
Length	6,8	m	22.3	ft
Fuselage width	0,63	m	2.07	ft
Fuselage height	0,81	m	2.66	ft
Empty weight with min. equipment approx.	245	kg	540	lbs.
Max. water ballast in the wings	190	kg	420	lbs.
Fin ballast tank capacity	5,5	kg	12.1	lbs.
Max. take off weight	450	kg	992	lbs.
Wing loading g (payload 75 kg, 165 lbs.)	31	kg/m <sup>2</sup>	6.34	lbs/ft <sup>2</sup>
Max. wing loading.	43,8	kg/m <sup>2</sup>	8.98	lbs/ft <sup>2</sup>
Max. speed VNE	250	km/h	135	kts
Stall speed W/S=32 kg/m <sup>2</sup> , 6.55 lbs/ft <sup>2</sup>	65	km/h	35	kts

### Description of the components

<b>Wings:</b>	GFRP-foam-sandwich-skin GFRP-Rovings
<b>Elevator:</b>	GFRP-skin
<b>Ailerons, horizontal tailplane and rudder:</b>	GFRP-foam-sandwich-skin
<b>Fuselage:</b>	GFRP-skin
<b>Undercarriage:</b>	Retractable, assisted by a gas strut, spring mounted, internal drum brake, fully sealed landing gear box. Tyre: 5.00 - 5 (dia. 362 mm) (14.25 in) 4 PR or 6 PR
<b>Tailwheel:</b>	Tyre 200 x 50 2 PR
<b>Tow release:</b>	Safety release "Europa G73 or G 88". for winch launch and aerotow near the C.G. <b>additional as option</b> "nose release E75 or E 85" installed under the instrument panel only for aerotow.

Cockpit: In flight adjustable rudder pedals and adjustable seat back for either automatic or manual parachutes, adjustable head rest. Large single piece clear plexiglas canopy, hinged at the nose, supported by a gas strut. Instruments and instrument panel covered by a housing which is held on by 6 screws - easily removable for unhindered access to instruments. Controls for undercarriage and dive brakes are on the left hand side of the cockpit. Parallelogram control column stick for the elevator. This eliminates PIO's in rough air. Release lever for elevator trim on control stick.

Dive Brakes: Schempp-Hirth dive brakes on the upper wing surface.

Tailplane: T-Tail with conventional stabilizer-elevator and spring trim.

Water ballast system:

95 litre (25 US gal.) or 65 litre (17 US gal.) water ballast bags in each wing panel. A fin water ballast tank may be provided as an option. (5.5 litre or 1.45 US gal.)

Colour: Airframe: white  
registration numbers: grey RAL 7001  
or red RAL 30101 or  
RAL 3000  
or blue RAL 5012



1.3 Description of the cockpit, the controls and details

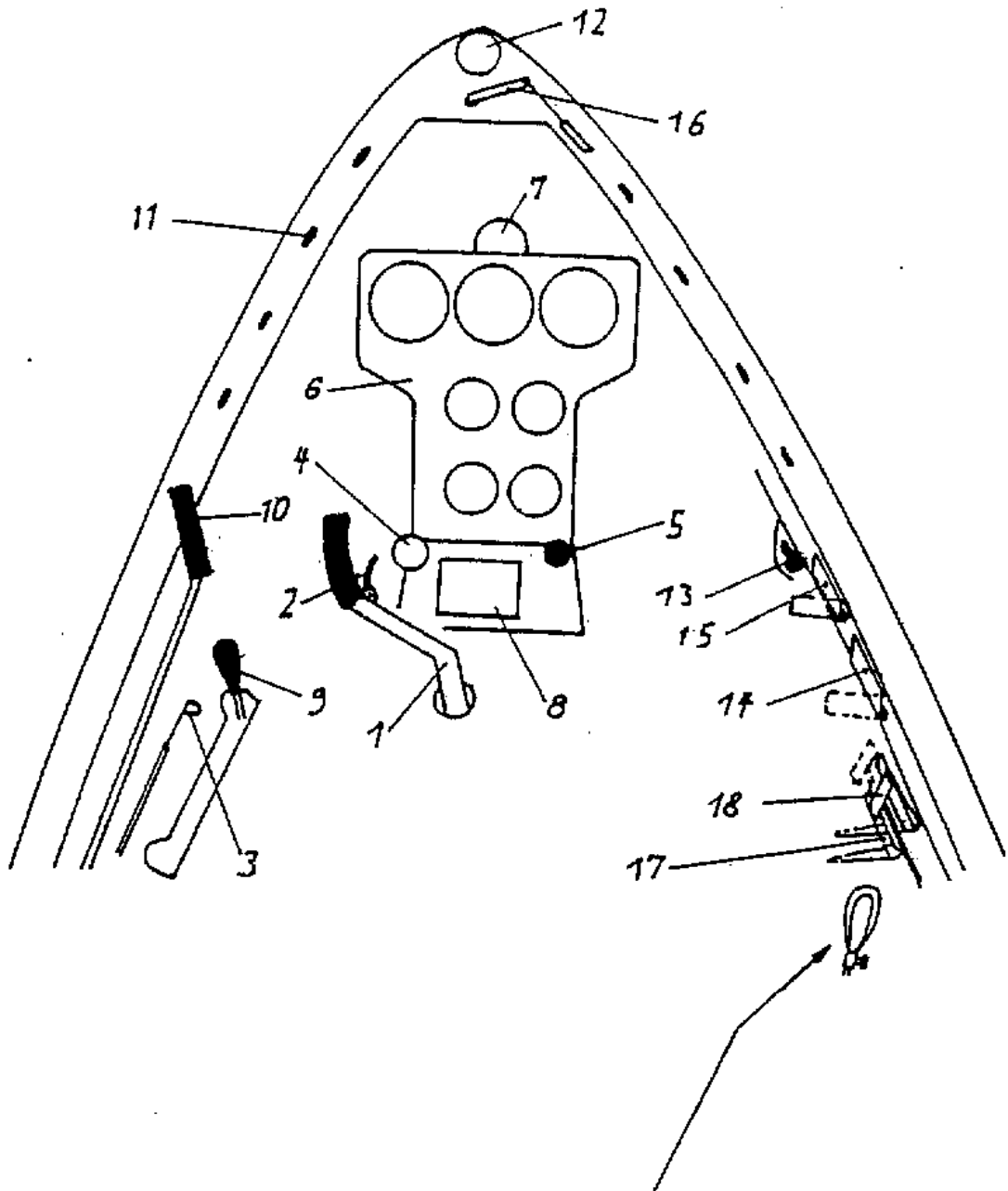

Pneumatic back rest adjustment with air release screw. The adjustment should only be used for minor comfort adjustment. For major adjustment a harder material like a foam block approx. 300 mm x 250 mm (12 in x 10 in.) should be used.

### 1.3 Description of the cockpit, the controls and details

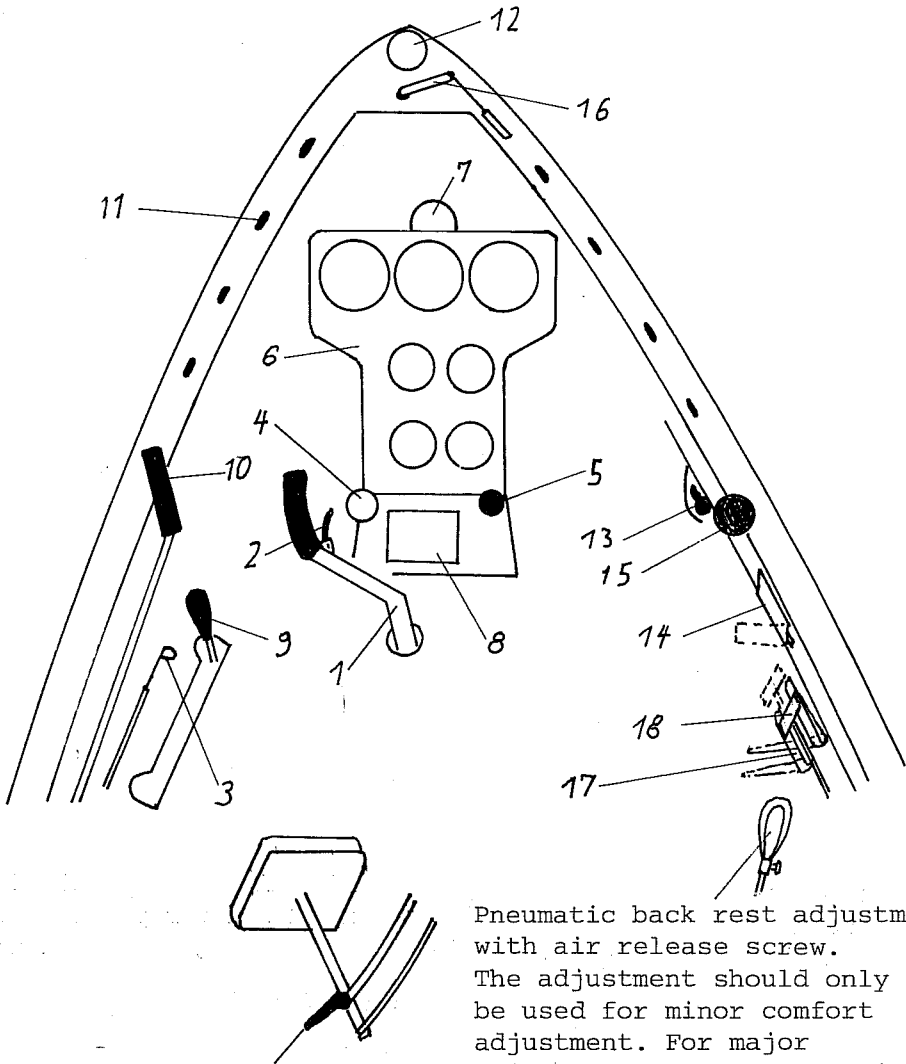

Adjustment lever for the head rest. Should the clamping force not be strong enough, tighten the other three mounting bolts.

Pneumatic back rest adjustment with air release screw. The adjustment should only be used for minor comfort adjustment. For major adjustment a harder material like a foam block approximately 300 mm x 250 mm (12 in x 10 in.) should be used.

- 1.) Control Column - Parallelogram type
- 2.) Release lever for the trim mechanism - green.  
To change the aircraft trim, the release lever should be pulled back, the control column brought to the required position and the release lever allowed to spring forward again.

- 3.) Trim position indicator and trim preselection lever



If the automatic trim mechanism (see 2 above) needs further adjusting (high speed flying), loosen the release lever and adjust by pushing forward the indicator lever.

- 4.) Tow release knob - yellow.

- 5.) Rudder pedal adjustment knob - black  
By pulling on the knob, the locking pin will be disengaged and the rudder pedals can be pulled back towards the pilot or pushed forward away from the pilot.

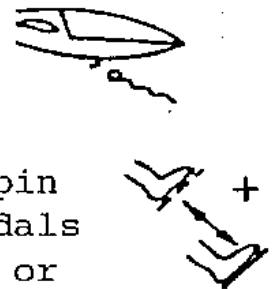

- 6.) Instrument Panel

After removing the side screws at the base 2 x M 6 the whole panel can be taken out and after removing the screws attaching the cover to the panel 6 x M 4, the cover can be removed.

- 7.) Compass installation position.

- 8.) Radio installation position.

- 9.) Undercarriage retraction - extension lever - black  
forward - undercarriage down  
back - undercarriage retracted

The undercarriage is locked in the extended position by an overcentre locking arrangement, and an additional safety catch at the handle. The handle is to be turned to the cockpit wall.



- 10) Airbrake handle - blue  
The wheel brake is operated at the end of the air brake handle travel.



- 11) Constantly open anti fooging air vents  
12) Main air vent  
13) Air vent operating knob - pushed in - closed  
pulled out - open

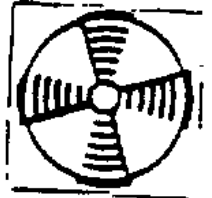

- 14) Canopy opening lever - white  
towards the nose - closed  
into cockpit - open



- 15) Emergency canopy release - red  
pull to release



Note: For emergency release only operate the emergency release 15). By this action the canopy opening lever will also be operated and a hook at the rear canopy lock will be rotated underneath the fuselage part of the canopy frame. Because of the hook in case of emergency release the canopy will rotate around this point and will leave the fuselage in a safe and fast way. The spring will open the canopy at the nose far enough to be blown away by the oncoming air.

- 16) Locking mechanism for the emergency canopy release.  
Towards the front - locked.

**Checking the emergency release on the ground:**

Pull the emergency release knob, the canopy should spring open at the nose.

**Reinstalling the canopy:**

Pull the canopy hinge into the open position. Replace the emergency release spring. Two people are required to hold the canopy - one at the nose the other at the rear. The emergency release locking mechanism should be in the open position. Place the canopy on the hinge and press down. Relocate the locking mechanism. Push the hook forward at the rear canopy lock until it snaps in.

- 17) Wing water ballast dump levers - silver  
upper lever - right hand water bag  
lower lever - left hand water bag  
forward - valve closed  
into the cockpit - valve open



- 18) Fin waterballast dump lever.  
Push to the front to dump. The wing waterballast can only be dumped after dumping the fin waterballast.

## 10.) Airbrake handle - blue

The wheel brake is operated at the end of the air brake handle travel.

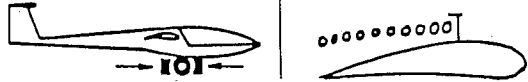

## 11.) Constantly open anti fogging air vents

## 12.) Main air vent

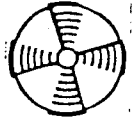
13.) Air vent operating knob - pushed in - closed  
pulled out - open14.) Canopy opening lever - red  
towards the nose - closed  
into cockpit - open15.) Emergency canopy release - red  
pull to release.

Note: for emergency release first open the canopy opening 14) and second the release knob 15). The spring will open the canopy at the nose far enough to be blown away by the oncoming air.

16) Locking mechanism for the emergency canopy release.  
towards the front - locked.

Checking the emergency release on the ground:

Pull the emergency release knob, the canopy should spring open 1 - 2 cm (.4 in. to .8 in.) at the nose, even with the normal canopy opening lever closed.

Reinstalling the canopy:

Pull the canopy hinge into the open position. Replace the emergency release spring. Two people are required to hold the canopy - one at the nose the other at the rear. The emergency release locking mechanism should be in the open position. Place the canopy on the hinge and press down. Relocate the locking mechanism.

17.) Wing water ballast dump levers - silver  
upper lever - right hand water bag  
lower lever - left hand water bag  
forward - valve closed  
into the cockpit - valve open

## 18.) Fin waterballast dump lever (option).

Push to the front to dump. The wing waterballast can only be dumped after dumping the fin waterballast.

## 2. Operating limitations

2.1 Airworthiness category:  
"U" Utility

### 2.2 Approved flight regimes

Airworthiness category "U"

#### A) With waterballast

1. Flight according to VFR (day light)

#### B) Only without waterballast

1. Cloud flying (day light): permitted when properly instrumented see 2.3 (not permitted in the USA and Canada)

**Caution:** Aerobatics are not permitted

### 2.3 Required minimum equipment

As required minimum equipment only the instruments and equipment specified in the equipment list (see maintenance manual) or in the master equipment list are to install.

#### a) General

##### Airspeed indicator

Range: 0-300 km/h (0-165 kts)

Speed range markings:

Green arc	90-175 km/h	48-95 kts
Yellow arc	175-250 km/h	95-135 kts
Redline at	250 km/h	135 kts
Yellow triangle	90 km/h	48 kts
(recommended approach speed)		

**Note:** The airspeed indicator is to be connected to the front static ports.  
Please refer to the calibration curve sect. 6.8.

##### Altimeter

Altimeter with fine range pointer, 1 turn max. 1000 m (3000 ft)

##### Four piece symmetrical safety harness

##### VHF - transceiver

**Parachute** automatic or manual type or a back cushion approximately 8 cm (3 inches) thick.

**Outside air temperature gauge** with probe in the landing gear box. Marking blue for temperature below 2°C, (36°F).

##### Required placards, check lists and this flight manual

b) **In addition for cloud flying** (not permitted in the USA, Canada and Australia):

Magnetic compass

Variometer

Turn and bank

**Remark:** Experience has shown that the installed airspeed system may be used for cloud flying.

## 2.3 ff Limitations placards

Type: DG – 300 Serial No.: 3E		
Year of construction:		
Maximum airspeeds	km/h	kts.
Winch launching	130	70
Aero-tow	175	95
Manoeuvring $V_A$	175	95
Rough air	175	95
Maximum speed $V_{NE}$	250	135
Aerobatics are not permitted		
Maximum weights:		
Category U	450 kg	992 lbs.
Cockpit load (parachute included)		
Maximum:	110 kg	(242 lbs.)
Minimum	70 kg	(154 lbs.)

**Gepäck max. 15 kg  
baggage max. 33 lbs.**

**Sollbruchstelle max. 680 da N  
rated load max. 1500 lbs.**

**Reifendruck 2 bar  
Tyre pressure 28 psi**

Tail wheel

**Reifendruck 3,5 bar  
Tyre pressure 49 psi**

Main wheel

**Cockpit Check**

1. Lead ballast (for under weight pilot)?
2. Fin ballast tank emptied or correct amount filled in?
3. Parachute worn properly?
4. Safety harness buckled?
5. Seat back and pedals adjusted?
6. All controls and knobs in reach?
7. Altimeter?
8. Dive brakes cycled and locked?
9. Control check ? (One person at the control surfaces).
10. Trim?
11. Canopies locked?

## limits for use of the waterballast tank

minimum	°C	13.5	17	24	31	38
ground temperature	°F	56	63	75	88	100
maximum flight altitude	m	1500	2000	3000	4000	5000
above GND	ft.	5000	6500	10000	13000	16500

Altitude	m	0-3000	4000	5000	6000
VNE indicated	km/h	250	243	230	218

Altitude	ft	0-10000	13000	16000	20000
VNE indicated	kts.	135	131	124	117

Other cockpit placards see section 1.3

## 2.4 Airspeed limits

	km/h	fts
Never-exceed airspeed	VNE = 250	135
Maximum airspeed in rough air	VRA = 175	95
Manoeuvring speed Category "U"	VA = 175	95
Maximum airspeed for landing gear operating	VLO = 175	95
Maximum airspeed for aero tow	VT = 175	95
Maximum airspeed for winch launch	VW = 130	70

### Remarks

Rough air is air motion such as wave rotors, storm cloud turbulence, dust devils and turbulence that one often encounters near mountain tops.

The manoeuvring speed is the highest speed at which it is allowed to apply full control deflections. At maximum airspeed only deflections of up to 1/3 full deflection are allowable. Attention must be paid to the fact that at higher altitudes the true airspeed is greater than the indicated airspeed.

This fact has no influence on the strength and the aerodynamic loads on the sailplane. But for flutter prevention the following indicated airspeeds are not to exceed.

Altitude	m	0-3000	4000	5000	6000
VNE indicated	km/h	250	243	230	218

Altitude	ft	0-10000	13000	16000	20000
VNE indicated	fts.	135	131	124	117



## 2.5 Maximum G-Loadings

The following G-Loadings are not to be exceeded:

### Airworthiness category "U"

at manoeuvring airspeed	VA	+5.3	-2.65
at maximum airspeed	VNE	+4	-1.5

## 2.6 Weights

Empty weight without instruments: approx. 245 kg 540 lbs.

Maximum weight: category "U" 450 kg 992 lbs.

The maximum weight without ballast in the wings has to be calculated as follows:

$G = GNT + G_{wings}$  see weight record page 14

maximum weight for the nonlifting parts:

GNT = 240 kg 529 lbs.

## 2.7 Center of gravity locations

The permissible in-flight center of gravity range is

160 mm to 325 mm

6.3 inches to 12.8 inches

behind datum (leading edge of the wing root rib).

## 2.8 Loading chart

With the cockpit loads as specified in the table of page 14, the C.G. limits will not be exceeded.

With lower pilot mass necessary lead ballast must be added in the seat. Ballast put on the seat (lead ballast cushion) must be fastened at the connections of the safety belts.

To determine the empty weight C.G. and its limits consult the maintenance manual.

The maximum weight is not to be exceeded.

The maximum weight of the nonlifting parts will not be exceeded if you don't exceed the max. weight without waterballast as specified in the table of page 14.

**Removable Ballast (Option)**

The ballast box at the right hand side of the instrument console underneath the carpet can accommodate 3 lead ballast weights of min 2.16 kg (4.76 lbs) each. Each weight compensates a pilot mass of 3.6 kg (7.94 lbs). The lead ballast weights are to be fixed in the box with a M 8 wingnut.

**Note:** For Australia the removable ballast is standard and the min. cockpit load should not exceed 65 kg (143 lbs.).

**Baggage:** Maximum 15 kg (33 lbs)

Heavy pieces of baggage are to secure to the baggage compartment floors (screwing to the floors or with belts). Each floor can support 7,5 kg (16.5 lbs).

**Waterballast in the wingtanks**

Each wing water tank has a capacity of 95 l (25 US gal) or 65 l (17 US gal.). The permissible maximum amount of water ballast in the wings is dependent on the actual empty weight and the fuselage loading and must comply with the diagram 1 (ballast chart) limits. Only symmetrical loading is permissible.

**Waterballast in the fin tank (Option)**

The water ballast in the fin is to compensate the forward move of the C.G. due to the waterballast in the wings. The amount is dependent on the amount of the waterballast in the wings and must comply with the diagram 2 limits.

As it is dangerous to fly with empty wing tanks while ballast is resting in the fin, it is prohibited to fill water into the fin tank if there is any risk of icing. The flight conditions must comply with the following table:

min. ground temperature	°C	13,5	17	24	31	38
	°F	56	63	75	88	100
max.flight altitude	m	1500	2000	3000	4000	5000
	ft	5000	6500	10000	13000	16500

In addition the outside air temperature gauge is to watch. The OAT should not be lower than 2°C (36°F).

Record of weight and balance

weighed on:																							
by:																							
Equipment list dated:																							
Empty weight:																							
	kg																						
	lbs.																						
Empty weight																							
C.G. behind datum	mm																						
	inch																						
Maximum weight without wing ballast	kg																						
	lbs.																						
Minimum cockpit load	kg																						
	lbs.																						
Maximum cockpit load	kg																						
	lbs.																						
max. water ballast	kg																						
max. cockpit load	lbs.																						
Inspector signature, stamp																							

The result of every new weight and balance (see maintenance manual) is to enter into this table.

**DG-300 Ballastplan**

for determination of max. water ballast in the wing tanks  
at max. TOW 450 kg

**Diagram 1**

1 kg = 2.2046 lbs.

**max. waterballast in the wings**

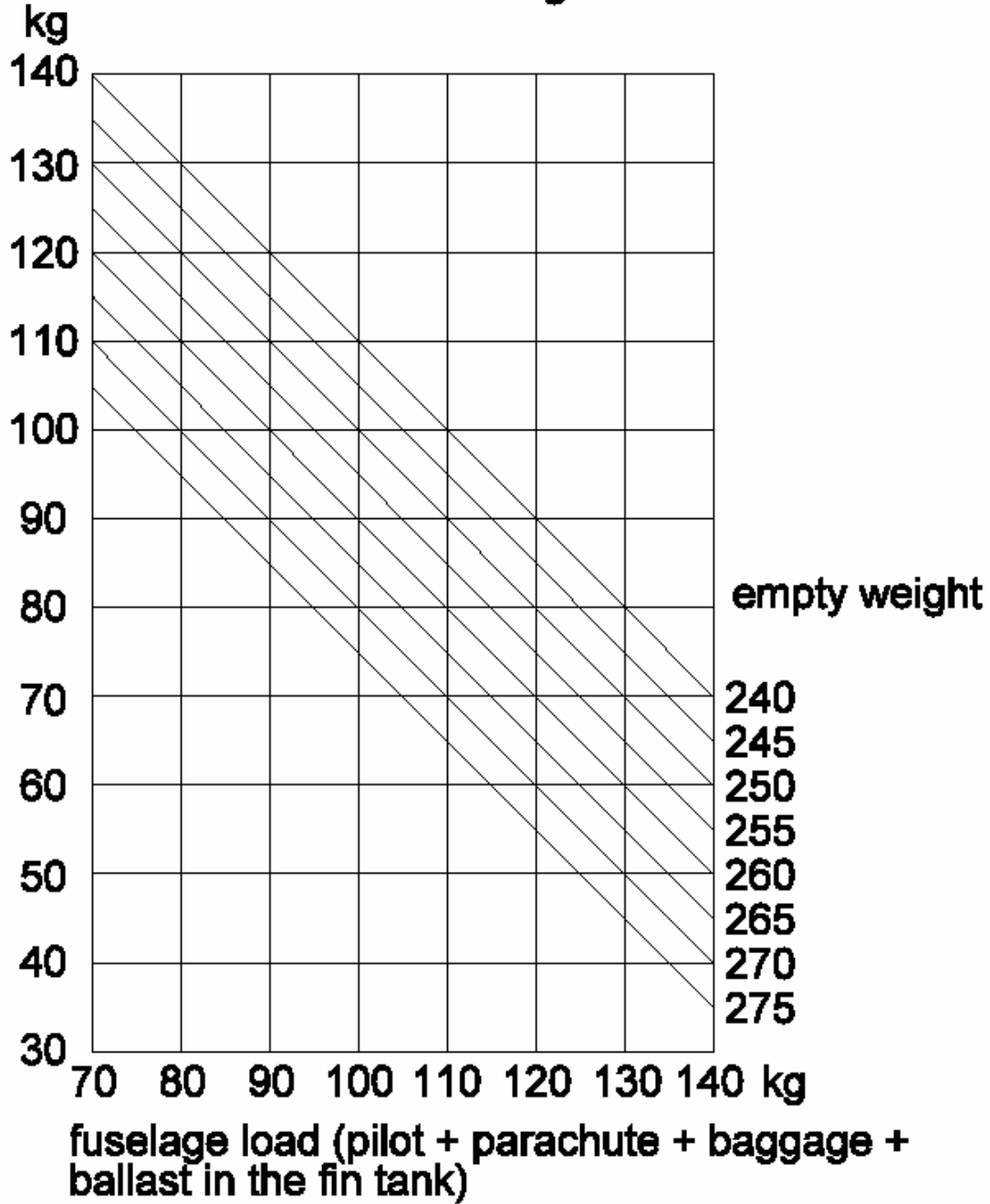

diagram 2

DG-300 ballast chart

for determination of max. waterballast in the fin tank

US, english measures

metric

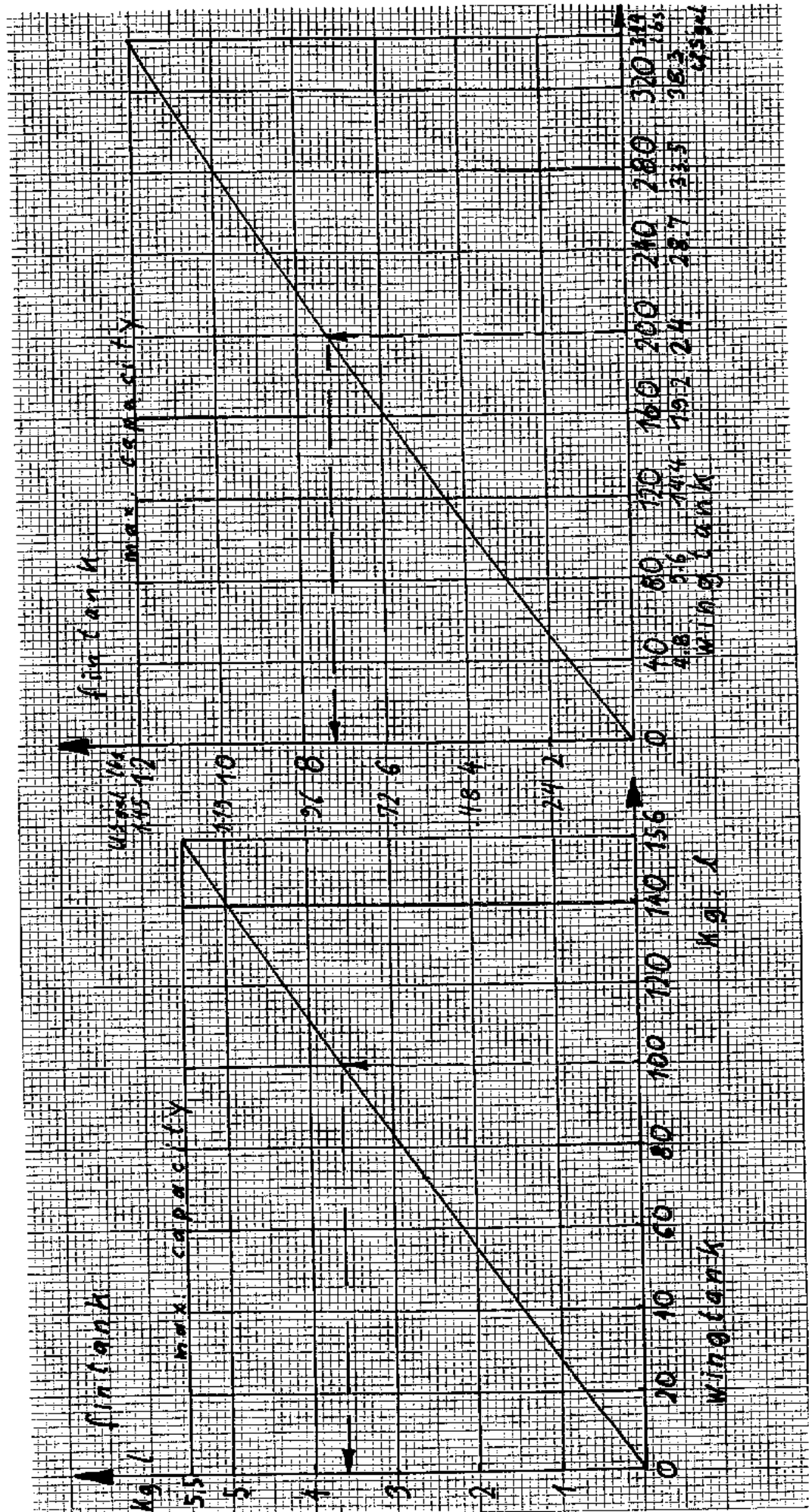

**2.9 Tow Release**

Safety tow release "Europa G 73/1-83" or "Europa G 88/1-83" for winch launch and aero tow.  
 Additional as option "Nose release E 75/1-85" or "Nose release E 85/1-85" only for aerotow.

**2.10 Weak Links**

max.      recommended

Winch launch and aero tow	6800 N	6000 N	+10%
	680 daN	600 daN	+10%
	1500 lbs.	1320 lbs.	+10%

**2.11 Tire Pressure**

Mainwheel	3.5 bar (49 PSI)
Tailwheel	2 bar (28 PSI)

**2.12 Crosswinds**

The maximum crosswind component according to the airworthiness requirements for take-off and landing is 15 km/h (8 kts).

**2.13 Length of the towing cable**

Length of the towing cable for aerotow 30 - 70 m (100 - 230 ft.).

### 3. Emergency procedures

#### 3.1 Spin recovery

Apply rudder opposite to spin direction, pause, then ease stick forward until the rotation ceases, centralize the controls and carefully pull out of the dive.

The ailerons should be kept neutral during recovery. Waterballast in both wings does not influence the spin characteristics but increases the nose down pitch during spin recovery.

	unballasted	max T.O.W.
Height loss during recovery		
m	40-60	50-100
ft	130-200	160-330
max. speed during recovery		
km/h	150	190
kts	81	103

#### 3.2 Canopy jettison / bail out

To bail out open the red canopy emergency release lever (lever into cockpit). The canopy will be opened by a spring and blown away by the oncoming air. The low sides of the cockpit allow for a quick push-off exit.

#### 3.3 Recovery from unintentional cloud flying

Spins are not to be used to loose altitude. In emergency, pull out the dive brakes fully before exceeding a speed of 200 km/h and fly at 200 km/h (108 kts) until leaving the cloud.

At higher speeds pull out the dive brakes very carefully by reason of high aerodynamic and g-loads.

#### 3.4 Emergency wheel up landing

It is not recommended to execute a wheel up emergency landing, as the energy absorption capability of the fuselage is much smaller than of the landing gear. After a gear up landing the tow release must be checked for damage. If damaged, the tow release must be replaced before the next take off.





3.5. Rain and Icing

1. Influence on flight characteristics

Rain and light icing raise the stall speed, sink speed and landing approach speed slightly.

2. Water Ballast

When the OAT (outside air temperature) sinks under 0°C (32°F) there is a danger that the water ballast may freeze. Dump the water before you reach freezing altitude or descend to lower altitudes.

3.6. Leaking water tanks

If you suspect a tank is leaking dump the water immediately.

4. Normal operation4.1 Daily Inspection

1. Are the main wing pins in and safetied?
2. Any foreign objects?
3. Finballasttank emptied or correct amount filled in (see 5.3)? (In case of doubt dump the fin tank). Is the stabilizer safetied?
4. Check the rudder for hinge play and proper safety-catch.
5. Check the tire and landing gear.  
Dirt in the front strut can hinder the landing gear from locking over center the next time!
6. Hook-up check. Is the tow release clean?
7. Check all control surfaces for free movement and play.
8. Look for flaws such as bubbles, holes, bumps and cracks in the surface. Don't take off if there is any damage.
9. Instrument and radio check.

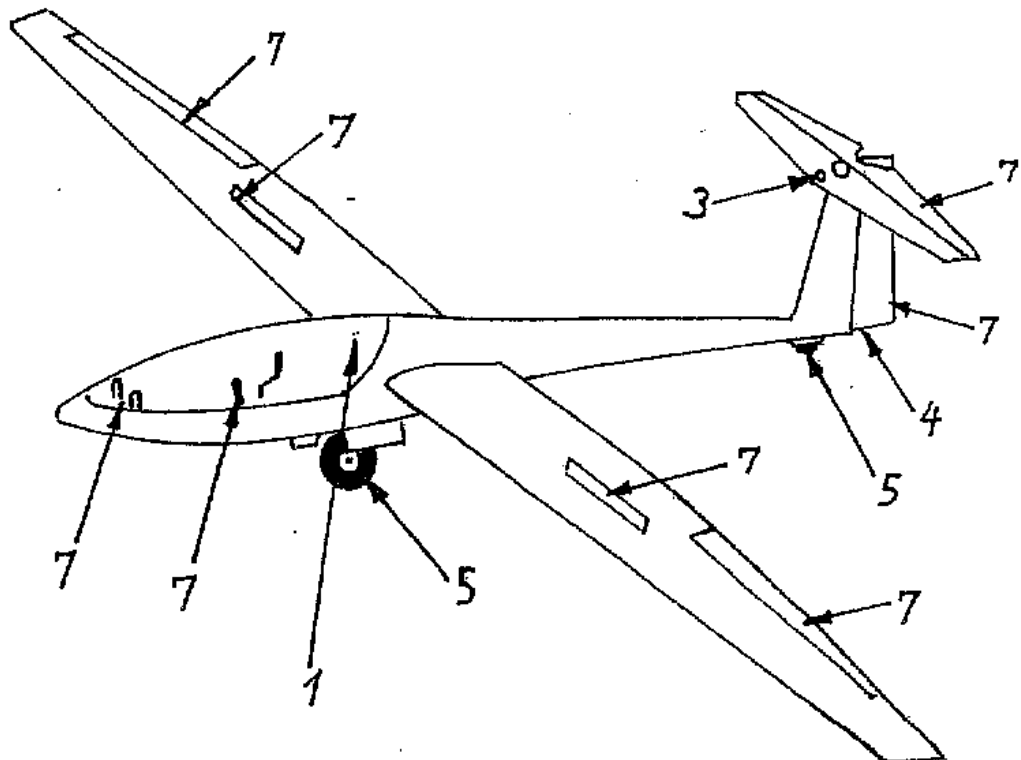

4.2. Cockpit Check

1. Lead ballast (for under weight pilot)?
2. Finballasttank emptied or correct amount filled in?
3. Parachute worn properly?
4. Safety harness buckled?
5. Seat back and pedals adjusted?
6. All controls and knobs in reach?
7. Altimeter?
8. Dive brakes cycled and locked?
9. Control check? (One person at the control surfaces).
10. Trim?
11. Canopy locked?

4.3 Aerotow-winch launch

Due to the towhook position in the middle of the fuselage (underside) and due to the excellent effectivity of the ailerons and rudder the possibility of wing stalling or wing dropping even on a slow starting aerotow is reduced to a minimum. Take-off with strong crosswind is possible without problems.

Aerotow

- a) If only a C.G. release is installed, then the aerotow is to be executed with this release. Set the trim full nose down for aerotow.
- b) If an additional tow release for aerotow is installed, only this release should be used for aerotow. Adjust the trim for aerotow so that the indicator is 2,5 cm (1 inch) behind the forward position.
- c) General:

Hold the aircraft on the ground until airspeed of 75-80 km/h (40-43 kts) is achieved before lifting off. On a rough airfield hold the control stick tight. The undercarriage can be retracted at safety height during the tow. Normal towing speed is 100 - 130 km/h (54-70 kts). For a cross country tow - the speed can be as high as 200 km/h (108 kts).

Note: Aerotow with high take off weight requires a powerful tow plane. Many tow planes are not certified to tow gliders with high take off weights. Reduce the take off weight if necessary.

Winch launch (Only allowed at the C.G. release)

Set the trim on full nose down position for a winch launch. Use the normal winch launch procedure. After reaching 60 m (200 ft) gradually pull back some on the stick so that the glider will not pick up excessive speed. Recommended winch launch airspeed is 100-110 km/h (54-60 kts) not less than 90 km/h (49 kts) and not more than 130 km/h (70 kts). After reaching release altitude pull the tow release knob (do not wait for the automatic release to function)!

Note: Winch launch with high take off weight requires a powerful winch!

4.4 Free Flight

4.4.1 Stall Characteristics, level and turning flight

At stall speed the DG-300 begins to mush, there is no abrupt stall. The ailerons remain effective. Pulling up will induce the DG-300 to stall forward or over one side. A little forward stick and if necessary, opposite rudder will recover the sailplane with minimum loss of height. Rain influences these characteristics negligibly and stall recovery is accomplished without loosing more than 20 m (.65 ft.) altitude.

Stall Airspeeds in level flight

wing-loading	kg/m <sup>2</sup>	32	36	40	44	48	50
	lbs ft <sup>2</sup>	6,6	7,4	8,2	9	9,8	10,2
stall-speed	km/h	65	69	73	76	80	81
	kts	35	37	39	41	43	44

4.4.2 High speed flying

The parallelogram stick configuration adds to the stable flight characteristics of the DG-300. It helps to reduce the possibility of pilot induced oscillations. The DG-300 may be trimmed at any speed up to maximum. At high speeds the stick should be held at all times.

Do not exceed the maximum airspeeds see sect. 2.4!

4.4.3 Thermaling

Thanks to the long fuselage the DG-300 is directionally very stable.

Uneven lift can be optimized because of the excellent roll rate (45° to 45° in 3,5 - 4 sec.). The DG-300 is docile at slow speeds for centering in thermals.

4.5. Cloud Flying: not permitted in the USA and Canada, not permitted with waterballast!

Take care to fly cleanly. Do not induce a spin as a method for loosing altitude in the clouds. In case of emergency, pull out the dive brakes fully before exceeding a speed of 200 km/h and dive at 200 km/h (108 kts) to leave the cloud.

#### **4.6 Aerobatics (Utility Category)**

**Caution:** Aerobatics are not permitted



#### 4.7. Approach and Landing

It is recommended to jettison all water ballast before landing. In calm weather, approach at 90 km/h (48 kts). The very effective Schempp-Hirth dive brakes make a short landing possible. The DG-300 side slips well and the side slip may be employed as a landing technique, but is not necessary. While slipping the rudder is sucked in its displaced position. So it is recommended to train the slip at higher altitudes. Strong crosswind offers no problem.

Do not approach too slowly with fully extended dive brakes otherwise the aircraft may drop during flare out.

When flaring out keep the airbrake - setting you were using, opening them further may drop the sailplane. Clean the landing gear and tow release after landing in a muddy field. Dirt in the front strut can keep the landing gear from locking over center next time. Simply hosing with water is the best cleaning method.

#### 4.8 Flight with water ballast

##### 4.8.1 Wing tanks

A few hints for optimizing the wing loading:

**No water:** When the average rate of climb is below 1.5 m/sec. (300 fpm, 3 kts.).

**Approx. 27 U.S. gal., 100 ltr. water:**

When the average rate of climb is approx. 2-4 m/s (400-800 fpm, 4-8 kts.).

**Maximum water ballast:**

When the average rate of climb is 4 m/sec (800 fpm, 8 kts.) or more. Do not exceed the maximum gross weight when loading the water ballast. The maximum quantity of water allowed is dependent on the empty weight and the cockpit load. It must concur with Diagram 1. (sect. 2.8)

In flight the water drains at approx. 0.6 ltr./sec. (1 1/3 lbs./sec.). By timing the jettison the pilot can lighten the aircraft as he needs.

**Warning:** If there is a risk of freezing, dump the water before you reach freezing altitude or descend to lower altitudes.

Water ballast raises the approach speed, so it is recommended to dump the water before landing.

Dump the ballast before an outlanding in any case.

If you suspect a tank is leaking, dump all water immediately.

##### 4.8.2 Waterballast in the fin tank (Option)

For optimal thermaling performance and handling waterballast in the fin tank should be used to compensate the forward move of C.G. due to the waterballast in the wings. Please refer to sect. 2.8.

##### 4.8.3 Filling of the tanks see sect. 5.2., 5.3

After filling level the wings and check if the dump valves are tight. It is not allowed to fly with leaking watertanks as this may result in an asymmetric loading condition.

##### 4.8.4 Dumping of the waterballast

First dump the fin ballast tank by pushing forward the dump lever, than open both wing ballast tanks together. Do not empty 1 wing tank after the other, to avoid asymmetric loading condition.

##### 4.8.5 Valves leaking, servicing

Please refer to the maintenance manual sect. 1.8 and 4.1.



#### 4.9 Flight at high altitude and at low temperatures

With temperatures below 0°C (32°F) for instance when wave flying or flying in winter, it is possible that the control circuits could become stiffer.

Special care should be taken to ensure that there is no moisture on any section of the control circuits to minimize the possibility of freeze up. It could be advantageous to apply Vaseline along all the edges of the airbrake cover plates to minimize the possibility of freezing closed.

Apply the controls in short periods.

It is not allowed to carry waterballast.

#### Caution:

1. At temperatures below -20°C (-4°F) there is the risk of cracking the Gelcoat.

2. Attention must be paid to the fact at higher altitudes the true airspeed is greater than the indicated airspeed.

The max. speed VNE is reduced. See the following table:

Altitude	m	0-3000	4000	5000	6000
VNE indicated	km/h	250	243	230	218

Altitude	ft	0-10000	13000	16000	20000
VNE indicated	kts.	135	131	124	117

3. Dump the water ballast before you reach freezing altitude at +2°C (36°F) or descend to lower altitudes.

#### 4.10 Flight in rain (also see sect. 3.5)

With rain, the stall speed and landing speeds are increased. The rate of sink of the aircraft also increases remarkable.

## 5. Rigging and derigging

### 5.1 Rigging

1. Open the canopy.
2. Clean and lube the pins, bushings and the control connects.
3. With a helper on the wingtip, lead the wings into place. Sight through the wing main pin bushings to determine alignment. Push the main pins in as far as possible. Turn the handles up to the fuselage wall. Therefore pull out the white securing knob. Set the knob back in its locking position. The ailerons should be held at neutral for rigging, airbrakes closed.
4. Rigging of the stabilizer

Set the trim nose down.

Set the stabilizer on, so that the roller at the fuselage side push rod is inserted into the funnel at the elevator.

Watch carefully the procedure.

When the stabilizer is set down laying on the fin push it back. The roller will slide forward in the funnel if you will hold the elevator in the pertinent position.

Use an 8 mm wrench (supplied with your glider) to tighten the front mounting bolt. Turn it so that the securing spring engages into the slit of the bolt.

Check for correct elevator connection by looking through the plexiglas window at the upper surface of the stabilizer.

5. Tape the gaps of the wing-fuselage junction.
6. Positive control check.

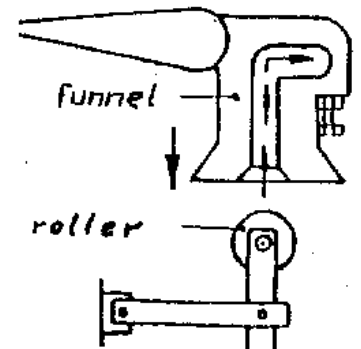

## 5.2 Filling the wing water ballast tanks

For filling the water ballast pull back the lever (top-right tank, bottom-left tank) in the cockpit.

Place one wingtip on the ground. Attach the hose supplied with your glider in the water outlet on the lower surface of the wing.

**Warning:** Fill the hose from your water containers but never from a mains pressure water supply. Filling the wing tanks with excessive pressure (more than 0.2 bar, 3 psi) will definitely burst the wing shell!

Fill with the desired amount of water, remove the hose and close the valve with the water ballast lever. Place the other wingtip on the ground and fill the other tank.

In case the valve leaks slightly, you may try to pull out the PVC pushrod of the valve to tighten it. If this cannot be done successfully refer to maintenance manual 1.8.2 and 4.1.

It is not allowed to fly with leaking watertanks, as this may result in asymmetrical loading condition.

After filling the tanks, check to see if the wings are balanced. If one wing is heavier, dump enough water to balance the wings.

## 5.3 a) Filling the fin water ballast tank Version with measuring stick.

The fin tank is to be filled after filling the wing tanks with the horizontal tailplane removed via the filling hole in the front rib of the fin. First shut the dump valve by pulling back the wire located inside the rear fuselage at the right hand side next to the rudder.

Unscrew the tank cap and fill clean water into the tank, using a funnel.

While filling, the water quantity can be determined by the measuring stick. Therefore unlock the stick from the rib by turning.

Read the quantity against the upper surface of the guide tube.

After filling press the stick downwards and lock it in the rib.

**5.3 b) Filling the fin waterballast tank**

New version (without measuring stick)

The fin tank is to be filled after filling the wing tanks.

Determine the amount see sect. 2.8.

Connect the transparent plastic filling hose via the hose connector GRS 10-12 to the hose which comes out of the left rear end of the fuselage.

The funnel can be suspended at the top of the rudder (Filling hose with connector and funnel are supplied with the aircraft).

Fill with clean water using a graduated measuring vessel.

In addition, the loaded quantity can be checked by holding the filling hose to the scale at the fin (communicating tube).

After filling, shut the dump valve by pulling back the wire located inside the rear fuselage at the right hand side next to the rudder.

Then remove the filling hose with the hose connector.

#### 5.4 Tie Down, Parking

There are holes in the wingtip skids for securing the sailplane. The fuselage should be tied down just ahead of the fin. Water ballast can be left in the wings, for a few days only, but not when there is the possibility of freezing! On sunny days the cockpit should be closed and covered.

**Note:** Longer parking with exposure to sun and humidity will cause premature aging of the skin of your sailplane.

#### 5.5 Derigging

Derigging follows the reverse of rigging. Water ballast must be dumped before. The airbrakes should be closed.

#### 5.6 Trailering

It is recommended to carry this valuable sailplane in a factory approved trailer.

Approved fitting points:

- Wings:**
1. Wing spar as close to wing root-rib as possible or a rootrib wing cradle.
  2. A wing cradle mid of the aileron.

**Stabilizer:** Cradles as desired.

- Fuselage:**
1. A felt lined fiberglass nose cap which does not extend over the canopy secured to floor.
  2. Fuselage dolly in front of the tow hook or a support attached to the lift pins, diameter 16 mm (.63 in.) (use plastic or brass bushings).
  3. Tail wheel well in trailer floor. Secure fuselage with a belt in front of the fin.

All aircraft structures should not be subject to any unusual loads. With high temperatures that can occur inside trailers, these loads in time can warp any fibre reinforced plastic sailplane.

The trailer should be well ventilated so as to prevent moisture build up which could result in bubbles forming in the gelcoat.

## 5.7 Service and Care

### Exterior surfaces of the fibereinforced plastic parts

The surfaces are coated by a UP-gelcoat. This gelcoat is protected by a hard wax coating which has been applied during production with a rotating disc ("Schwabbel" procedure). Do not remove the wax, this would lead to shading, swelling and cracking of the surface. In general the wax coat is very resistant. As soon as the wax coat is damaged or worn a new coat has to be applied (see maintenance manual sec. 3.1). If you store your aircraft often outside, this may be necessary every half year!

#### Hints for care:

- Wash the surface only with clear water using a sponge and chamois.
- The adhesive remains of tape may be removed with petroleum ether (pure petroleum spirit) which should be applied for some seconds only, otherwise this may lead to swelling of the gelcoat.
- More stubborn dirt which cannot be removed by washing may be cleaned off with siliconefree, waxcontaining car polishes (e.g. 1Z Extra)
- Longterm dirt and shading can be removed by applying a new hard wax coat (see maintenance manual sec. 3.1).
- Never use alcohol, thinner etc.. Do not use detergents for washing.
- Protect the surface from intense sunlight.
- Protect the aircraft from water and moisture, see also sec. 5.4 and 5.6.
- Remove water that has entered and allow the aircraft to dry out.
- Never store your wet aircraft in a trailer.

**Plexiglass canopy:**

- Use clear water and a chamois for cleaning.
- Stubborn dirt and small scratches can be removed by use of the "Schwabbel procedure" (see maintenance manual sect. 3.1).

**Metal parts:**

The pins and bushes for rigging the aircraft are not surface protected and to be covered with grease all the time.

The other metal parts, especially the control stick and all handles should be preserved with metal polishes occasionally.

**5.8 Towing on the ground**

- a) by towing at the tow hook using a rope with the standard double ring authorized for the release.
- b) by using a tow bar which is to be fixed at the tail dolly and a wing tip wheel.

The tow bar and wing tip wheel may be ordered through the Glaser-Dirks factory.

6. Additional Information6.1. Gliding Performance

wing loading	kg/m <sup>2</sup>	32	40	50
	(lbs/ft <sup>2</sup> )	6,5	8,2	10,2
min. sink	m/s	0,59	0,62	0,68
	(ft/min)	116	122	134
at V	km/h	78	87	98
	(kts)	42	47	53
best glide angle		1:41	1:41,5	1:42
at V	km/h	100	112	122
	(kts)	54	60	66

A variation in speed by  $\pm 10$  km/h (5 kts) from the above will decrease the best glide angle by 0,5 glide points and increase the min. sink rate by 1 cm/sec. (2 ft/min).

The polar curves can be seen on diagram 3. For optimum performance, the aircraft should be flown with a c.g. towards the rear of the allowable range. This especially improves thermaling performance. However the aircraft will be more pitch sensitive. The wing fuselage joint and the tailplane locking bolt hole should be taped up and the aircraft thoroughly cleaned to obtain maximum performance.

The polars on page 31 apply to a "clean" aircraft. With dirty wings or flight in rain, the performance drops accordingly.



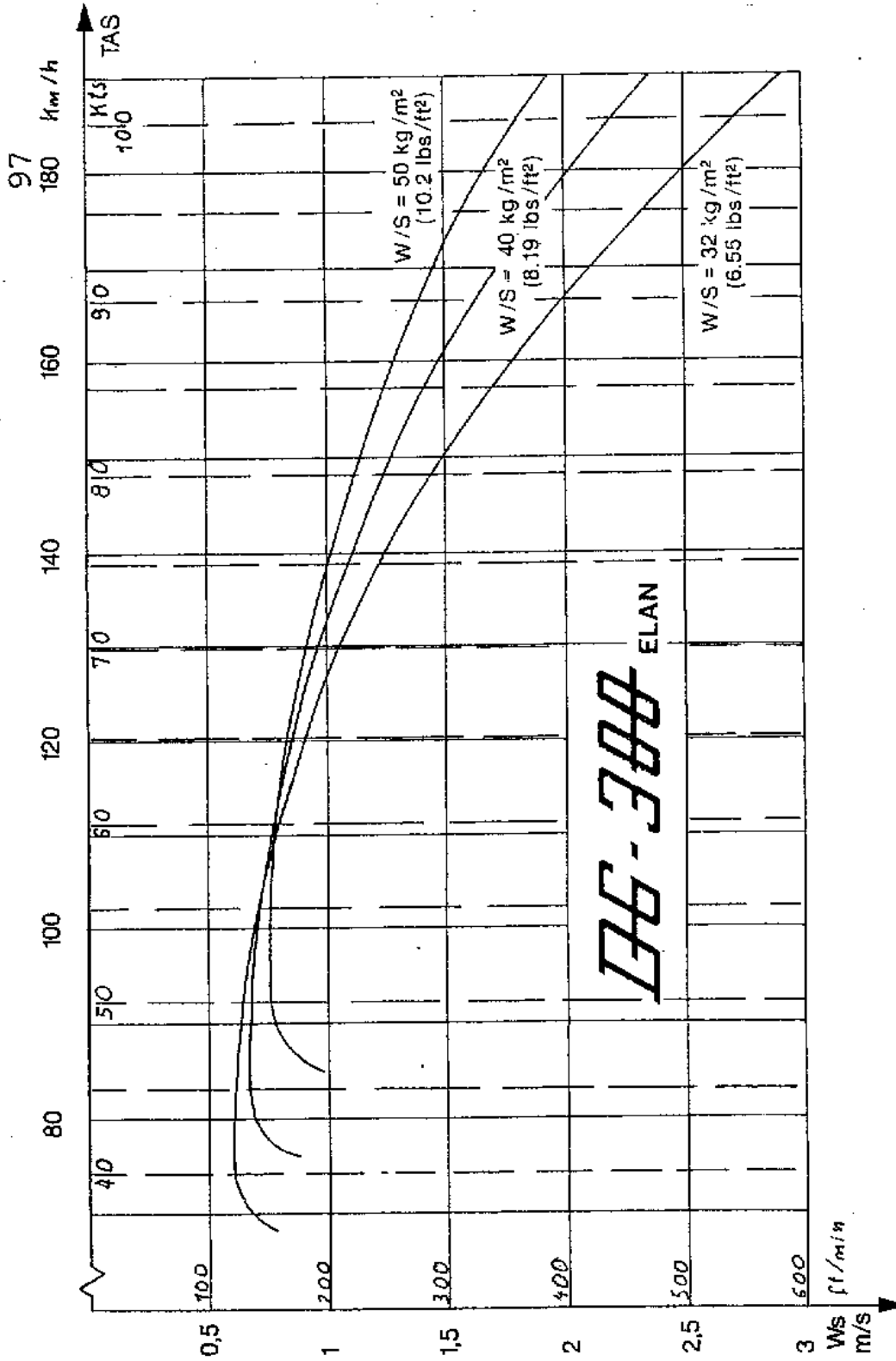

DG-300 Mc Cready polars

diagram 4

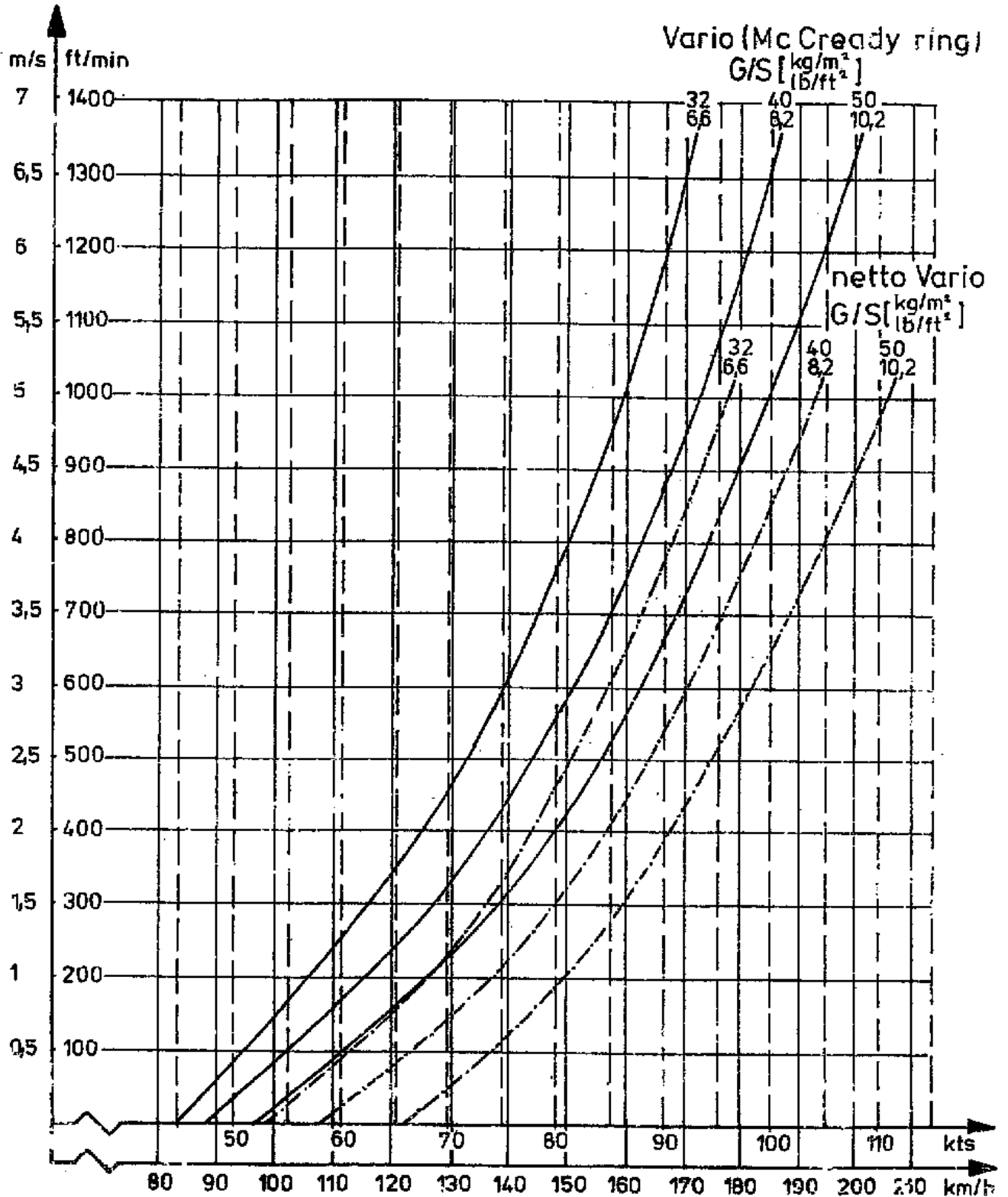

## 6.2 Maintenance

The "Instructions for continued airworthiness (maintenance manual) for the DG-300" have to be followed.

Before each rigging all the connecting pins and bolts should be cleaned and greased. This includes the control connectors. Every 3 months all the bearings and hinges should be cleaned and greased, see the greasing programme of the maintenance manual. Each year the control surface displacements, adjustments and general condition must be checked, see the maintenance manual.

## 6.3 Repairs and alterations

It is essential, that the responsible airworthiness authority be contacted prior to any alterations on the airplane to ensure, that the airworthiness of the sailplane is not impaired.

It is prohibited to execute the alteration without the approval of the airworthiness authority. The manufacturer will not be liable for the alteration or for damages resulting from changes in the characteristics of the aircraft due to alteration.

So it is strongly recommended to execute no alternatives which are not approved by the aircraft manufacturer.

External loads such as external camera installations are to be regarded as alterations!

Repair instructions can be found in the DG-300 repair manual. No repairs should be carried out without referring to the manual.

## 6.4 Tow hooks

The operating and maintenance instructions of the manufacturer, see maintenance manual DG-300, sect. 0.4, have to be followed.

## 6.5 Safety harness

The instructions in the manual for the type of safety harness installed in your DG-300 have to be followed.

## 6.6 3000 hour inspection and maximum total life time

See sect. 2.4 of the DG-300 maintenance manual.

## 6.7 Instruments

The instructions of the instrument manufacturer have to be followed.

6.8. Airspeed calibration

The ASI is connected to the front static ports

Indicated airspeed

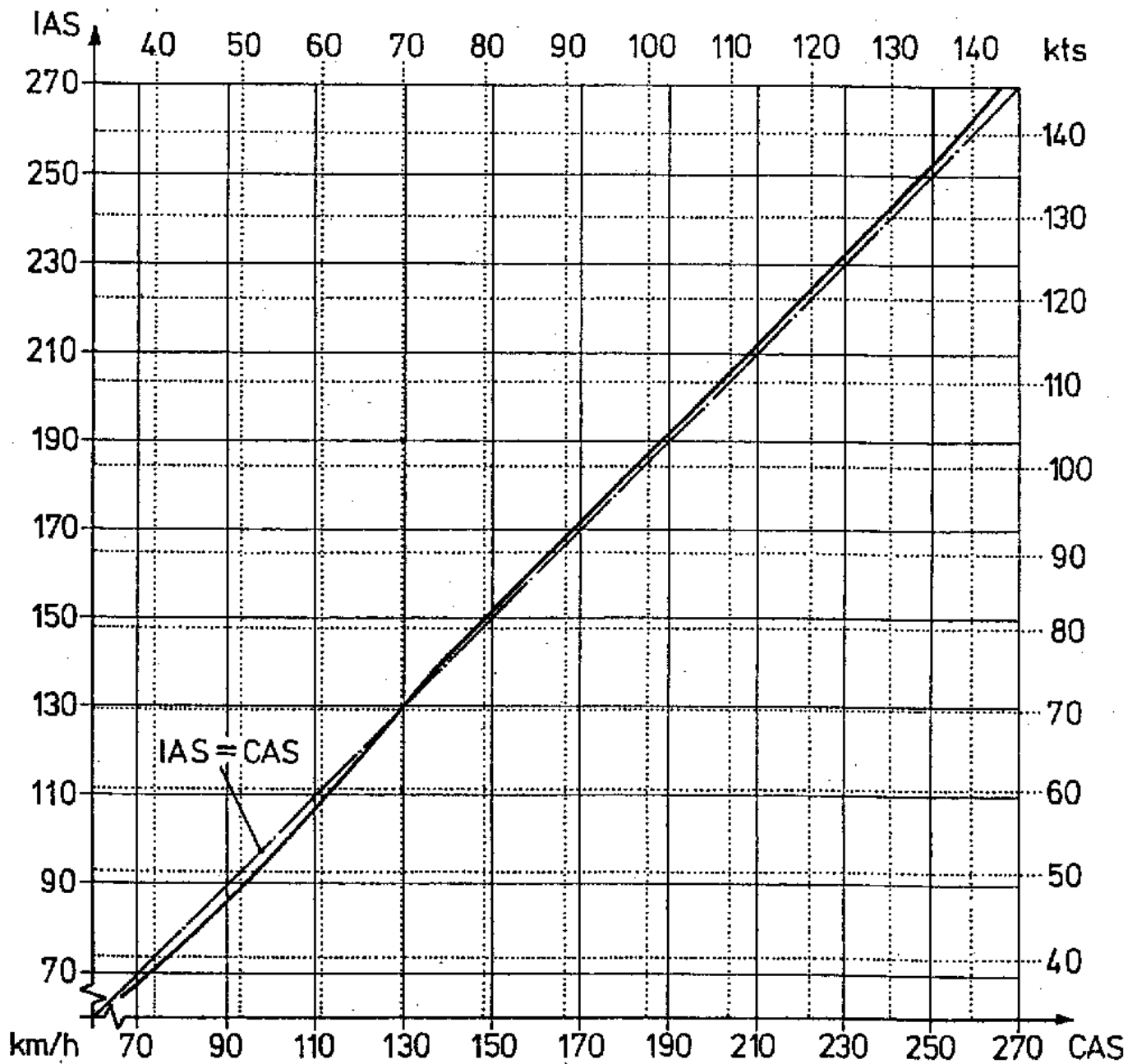

calibrated airspeed

Section 7

- 7. Supplements
- 7.1 Introduction
- 7.2 List of inserted supplements
- 7.3 Wingtips with winglets

**7.1 Introduction**

This section contains the appropriate supplements necessary to safely and efficiently operate the sailplane when equipped with various optional systems and equipment not provided with the standard sailplane.

**7.2 List of inserted supplements**

Date of insertion	Document No.	Title of the inserted supplement
Oct. 1995	7.3	Wingtips with winglets

## 7.3 Wingtips with winglets

### Section 1 Introduction

In the following text the changes to those sections of the flight manual which are affected by the installation of winglets at the wingtips will be given.

### Brief description

In addition to the wing configurations described in sections 1 up to 6 of the flight manual 15 m wingtips with winglets are approved.

The installation of the winglets to the wingtips must be executed during production of the glider or as a retrofit according to the technical note TN 359/17.

The height of the winglets is 0.35 m (13.8 in.).

### Section 4 Airworthiness limitations

1. Category "U" Utility:  
No change of limitations due to the winglets.
2. Category "A" Aerobatics  
(only DG-300 ELAN ACRO and DG-300 Club ELAN ACRO)  
Aerobatics must be executed with the normal wingtips. With winglets only the manoeuvres of category "U" are permissible.

### Section 5 Assembly and disassembly of the winglets

To assemble the winglets remove the normal wingtips first by inserting the 4 mm Allen key wrench which is kept with the rigging tools via the hole at the wing upper surface into the hexagonal hole of the securing pin. Screw this pin upwards as far as possible. Remove the wrench and pull off the wingtip. Plug in the wingtip with winglet and screw the securing pin downwards with the wrench as far as possible.

Removal of the winglets and reassembly of the wingtips is accomplished by the same procedure.

### Section 6 Gliding performance

Thanks to the winglets the max. L/D is increased by approx. two points.

The min. sink is reduced by approx. 0.01 m/s (0.4 ft/min.).